

Mutina

Phenomenon

by Tokujin Yoshioka



EN

General information
Laying and maintenance tips
Colors
Technical features
Packing



Phenomenon Rain

General information

collection	Phenomenon
design	Tokujin Yoshioka, 2010 – 2013 – 2022
production	Artisanal
material	Homogeneous unglazed porcelain stoneware straws, obtained by pressing and fixed on net
thickness	RAIN A: min 5 mm - max 7 mm RAIN B: min 5 mm - max 7 mm RAIN C: 5 mm
nominal sizes	RAIN A: net 25-30 cm (net 9 7/8" - 12") RAIN B: net 25-30 cm (net 9 7/8" - 12") RAIN C: net 25-30 cm (net 9 7/8" - 12")
specification	<ul style="list-style-type: none">- 7 colours: Bianco, Grigio, Fango, Nero, Blu, Verde, Rosa- 3 mosaic card shapes on net- The mosaic is assembled in sheets to give a "handmade look" to the surface. Rain A-B-C, Honeycomb A-B, Rock, Air, Wind, of the series Phenomenon represent the finest of modern-day Italian craftsmanship.- Each mosaic card is individually pressed with a bespoke 100-holes mould, expressly created to achieve a materic and artisanal feeling, then fired through a bespoke, patented, process.- Mutina patented production process and machines (Industrial Patent filed on 02/09/2010 under number MO2010A000247)- The cards are manually assembled accurately by expert hands to build a unique, innovative pattern.
awards	ICFF Editors Award Material 2011, Wallpaper Design Award 2011, Edida 2011, Selected for Adi Design Index 2011, Love Tag Azure Magazine 2012, Red Dot Design Award 2012, Interior Innovation Award 2014, Best of Best 2014
patents	Registered design n° 001912999-0011 – date of registration: 06/09/2011
category	UNI EN 14411 App G (BIA group) UGL

RAIN A

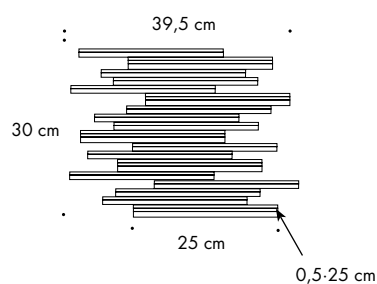

section

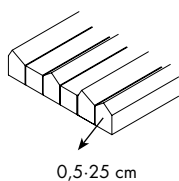

net 25-30 cm
net 9 7/8" - 12"

RAIN B

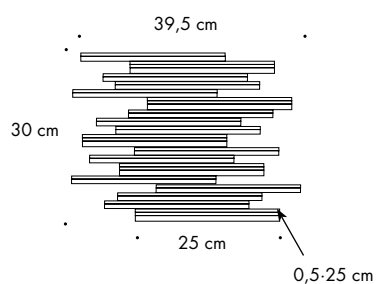

section

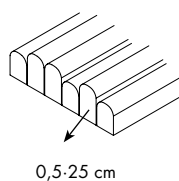

net 25-30 cm
net 9 7/8" - 12"

RAIN C

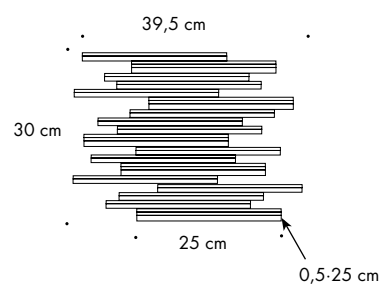

section

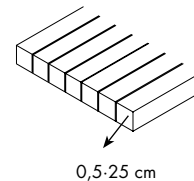

net 25-30 cm
net 9 7/8" - 12"

Laying and maintenance tips

use	Wall (RAIN A-B-C) – indoor, outdoor.
installation	Lay on perfectly flat, dry walls.
recommended adhesive	NON-RAPID-DRYING adhesive for porcelain stoneware to make it easier to fix the sheets.
recommended joints	2mm joints.
recommended fillers	CEMENT-BASED GROUT: (all mosaics). Grout 0.5 m ² at a time and wash thoroughly with clean water. Remove all traces of grout carefully before it dries completely. EPOXY GROUT: (rock, honey A only). Grout 0.5 m ² at a time and wash thoroughly with clean water. Remove all traces of grout carefully before it dries completely.
cleaning at the end of installation	CEMENT-BASED GROUT: Buffered acid (e.g. DETERDEK PRO by FILA, or similar). Wet the floor with water, dilute the product 1:5 with water and pour it on the floor. Wait for 2 or 3 minutes then use a white scotch brite pad and rinse well with clean water. EPOXY GROUT: Alkaline detergent (e.g. FILA CR10 by FILA). FILA CR10: apply pure, wait for 30 minutes then use a green scotch brite pad. SILICONE: Solvent for silicone (e.g. FILA ZERO SIL.). Pour it straight onto the stain, wait for 20 minutes and remove the mark using scotch brite. PAINT: Can usually be removed using water, but if resin-based paints or particular enamels have been used, it is best to ask the manufacturer which solvent is most suitable. RUST: stain remover es. FILA NO RUST. Apply the product onto the stain, leave for 15 minutes, remove the residue and rinse thoroughly.
general cleaning (installed tiles)	You are recommended to use ordinary neutral detergent diluted in water. Avoid using acid or alkaline products, waxes and/or impregnants. During ordinary cleaning it is recommended to use extremely abrasive items (such as scourers and iron or steel sponges) as little as possible. This recommendation must be adhered to rigorously in the case of tiles with a glossy surface finishing as they are more susceptible to the risk of scuffs, scratches and loss of shine, etc. In the event of heavy dirt or particularly textured surfaces, use an alkaline detergent and rinse after washing.
calibers (real size)	–

Colors

RAIN A



Rain A Bianco



Rain A Grigio



Rain A Fango



Rain A Nero



Rain A Blu



Rain A Verde

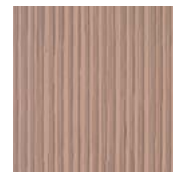

Rain A Rosa

RAIN B



Rain B Bianco



Rain B Grigio



Rain B Fango



Rain B Nero

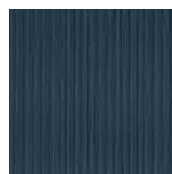

Rain B Blu



Rain B Verde

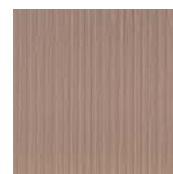

Rain B Rosa

RAIN C



Rain C Bianco



Rain C Grigio



Rain C Fango



Rain C Nero



Rain C Blu



Rain C Verde



Rain C Rosa

For information about the available grouts, please contact the sales department.

Mosaics: Honeycomb, Rock, Air, Wind

collection	Phenomenon
design	Tokujin Yoshioka, 2010 - 2013 - 2022
production	Artisanal
material	Homogeneous unglazed porcelain stoneware tesserae, obtained by pressing and fixed on net
thickness	HONEYCOMB A: min 5 mm - max 6 mm HONEYCOMB B: min 6 mm - max 8 mm ROCK: 5 mm AIR: 8 mm WIND: 7 mm
nominal sizes	HONEYCOMB A: net 30.30 cm (net 12".12") HONEYCOMB B: net 30.30 cm (net 12".12") ROCK: net 29.29 cm (net 11 ¹³ / ₁₆ ".11 ¹³ / ₁₆ ") AIR: net 30.30 cm (net 12".12") WIND: net 25.25 cm (net 10".10")
specification	<ul style="list-style-type: none"> - 7 colours: Bianco, Grigio, Fango, Nero, Blu, Verde, Rosa - 5 mosaic card shapes on net - The mosaic is assembled in sheets to give a "handmade look" to the surface. Rain A-B-C, Honeycomb A-B, Rock, Air, Wind, of the series Phenomenon represent the finest of modern-day Italian craftsmanship. - Each mosaic card is individually pressed with a bespoke 100-holes mould, expressly created to achieve a materic and artisanal feeling, then fired through a bespoke, patented, process. - Mutina patented production process and machines (Industrial Patent filed on 02/09/2010 under number MO2010A000247) - The cards are manually assembled accurately by expert hands to build a unique, innovative pattern.
awards	ICFF Editors Award Material 2011, Wallpaper Design Award 2011, Edida 2011, Selected for Adi Design Index 2011, Love Tag Azure Magazine 2012, Red Dot Design Award 2012, Interior Innovation Award 2014, Best of Best 2014
patents	Registered design n° 001912999-0011 – date of registration: 06/09/2011 Registered design n° 002336909-0001/0004 – date of registration: 31/10/2013
category	UNI EN 14411 App G (BIA group) UGL

HONEYCOMB A

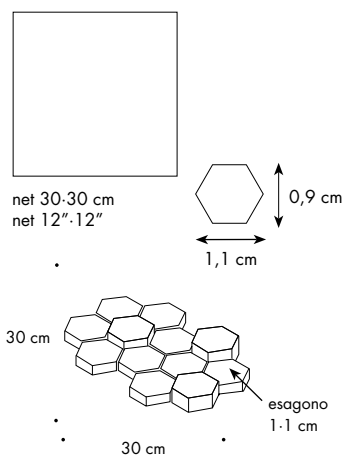

HONEYCOMB B

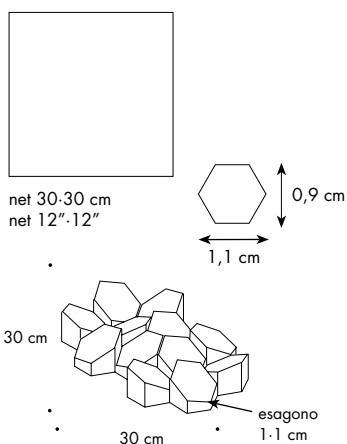

RACCORDO ESTERNO HONEYCOMB A + B

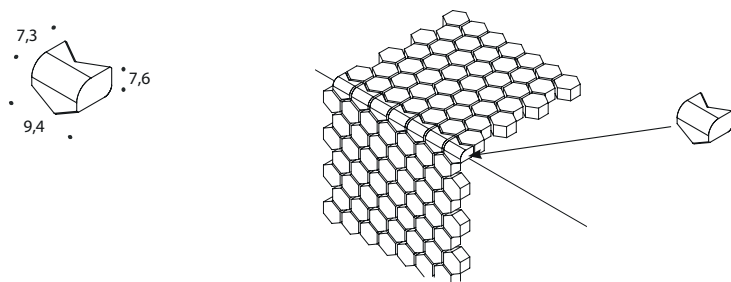

ROCK

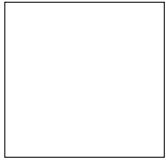

net 29·29 cm
net 11 13/16"·11 13/16"

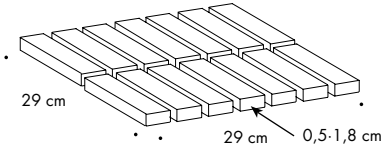

AIR

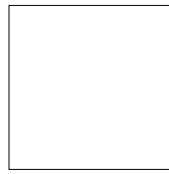

net 30·30 cm
net 12"·12"

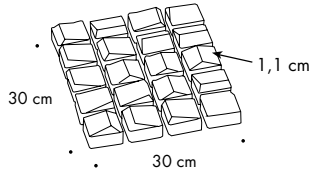
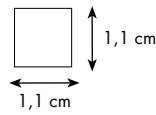

WIND

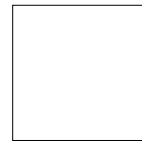

net 25·25 cm
net 10"·10"

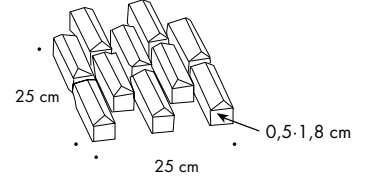

Laying and maintenance tips

use	Floor (ROCK, HONEY A), wall (ROCK, HONEY A, WIND, AIR, HONEY B) – indoor, outdoor.
installation	Lay on perfectly flat, dry walls.
recommended adhesive	NON-RAPID-DRYING adhesive for porcelain stoneware to make it easier to fix the sheets.
recommended joints	2mm joints.
recommended fillers	CEMENT-BASED GROUT: (all mosaics). Grout 0.5 m ² at a time and wash thoroughly with clean water. Remove all traces of grout carefully before it dries completely. EPOXY GROUT: (rock, honey A only). Grout 0.5 m ² at a time and wash thoroughly with clean water. Remove all traces of grout carefully before it dries completely.
cleaning at the end of installation	CEMENT-BASED GROUT: Buffered acid (e.g. DETERDEK PRO by FILA, or similar). Wet the floor with water, dilute the product 1:5 with water and pour it on the floor. Wait for 2 or 3 minutes then use a white scotch brite pad and rinse well with clean water. EPOXY GROUT: Alkaline detergent (e.g. FILA CR10 by FILA). FILA CR10: apply pure, wait for 30 minutes then use a green scotch brite pad. SILICONE: Solvent for silicone (e.g. FILA ZERO SIL). Pour it straight onto the stain, wait for 20 minutes and remove the mark using scotch brite. PAINT: Can usually be removed using water, but if resin-based paints or particular enamels have been used, it is best to ask the manufacturer which solvent is most suitable. RUST: stain remover es. FILA NO RUST. Apply the product onto the stain, leave for 15 minutes, remove the residue and rinse thoroughly.
general cleaning (installed tiles)	You are recommended to use ordinary neutral detergent diluted in water. Avoid using acid or alkaline products, waxes and/ or impregnants. During ordinary cleaning it is recommended to use extremely abrasive items (such as scourers and iron or steel sponges) as little as possible. This recommendation must be adhered to rigorously in the case of tiles with a glossy surface finishing as they are more susceptible to the risk of scuffs, scratches and loss of shine, etc. In the event of heavy dirt or particularly textured surfaces, use an alkaline detergent and rinse after washing. For large surfaces, the use of a floor washing machine is recommended. During every-day cleaning procedures, it is necessary to remember that certain types of dirt (dust, sand) increase the abrasive effect of foot-traffic. Therefore we recommend that you avoid bringing in this type of dirt, which comes in from the outside, by placing a door-mat at the entrance.
calibers (real size)	-

Colors

HONEYCOMB A

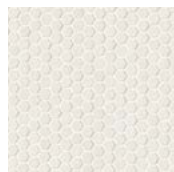

Honeycomb A Bianco

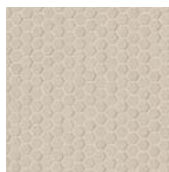

Honeycomb A Grigio

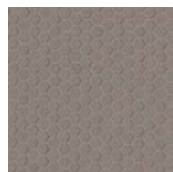

Honeycomb A Fango

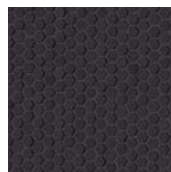

Honeycomb A Nero

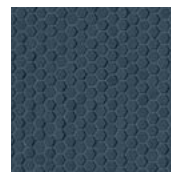

Honeycomb A Blu

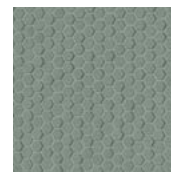

Honeycomb A Verde

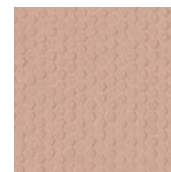

Honeycomb A Rosa

HONEYCOMB B

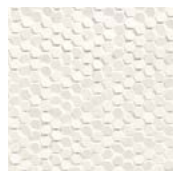

Honeycomb B Bianco

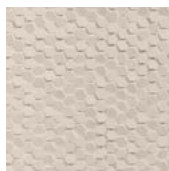

Honeycomb B Grigio



Honeycomb B Fango

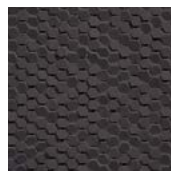

Honeycomb B Nero

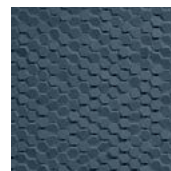

Honeycomb B Blu



Honeycomb B Verde

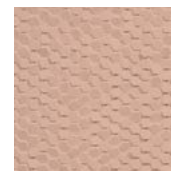

Honeycomb B Rosa

ROCK

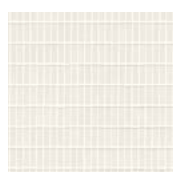

Rock Bianco

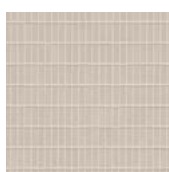

Rock Grigio

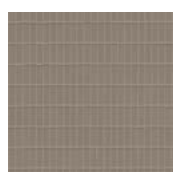

Rock Fango



Rock Nero

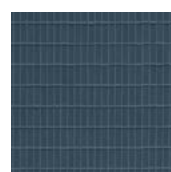

Rock Blu

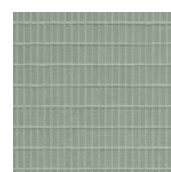

Rock Verde

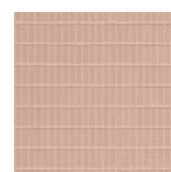

Rock Rosa

AIR



Air Bianco



Air Grigio



Air Fango



Air Nero

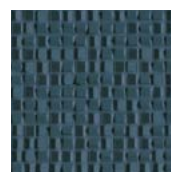

Air Blu

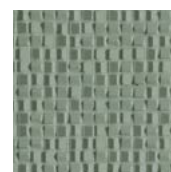

Air Verde



Air Rosa

WIND



Wind Bianco



Wind Grigio

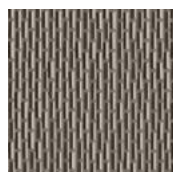

Wind Fango



Wind Nero

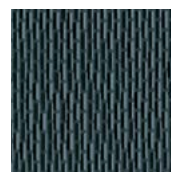

Wind Blu



Wind Verde



Wind Rosa

For information about the available grouts, please contact the sales department.

Phenomenon Glossy: Rain A, Honeycomb B, Rock

collection	Phenomenon Glossy
design	Tokujin Yoshioka, 2022
production	Artisanal
material	Homogeneous glazed porcelain stoneware tesserae and straws, obtained by pressing and fixed on net
thickness	RAIN A: MIN 5 mm - MAX 7 mm HONEYCOMB B: min 6 mm - max 8 mm ROCK: 5 mm
nominal sizes	HONEYCOMB B - 30X30 sheet ROCK - 29X29 sheet RAIN A - 25X30 sheet
specification	<ul style="list-style-type: none"> - 4 colours: Bianco Glossy, Nero Glossy, Oro, Argento - 3 mosaic card shapes on net - The mosaic is assembled in sheets to give a "handmade look" to the surface. Rain A, Honeycomb B, Rock, of the series Phenomenon represent the finest of modern-day Italian craftsmanship. - Each mosaic card is individually pressed with a bespoke 100-holes mould, expressly created to achieve a materic and artisanal feeling, then fired through a bespoke, patented, process. - Mutina patented production process and machines (Industrial Patent filed on 02/09/2010 under number MO2010A000247) - The cards are manually assembled accurately by expert hands to build a unique, innovative pattern.
patent	Registered design n° 001912999-0011 - date of registration: 06/09/2011
category	UNI EN 14411 App G (BIA group) GL

RAIN A

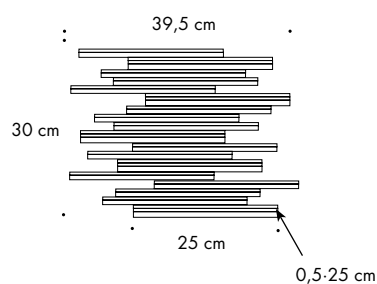

net 25-30 cm
net 9 7/8"-12"

section

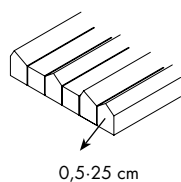

HONEYCOMB B

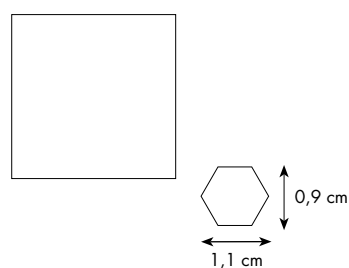

net 30-30 cm
net 12"-12"

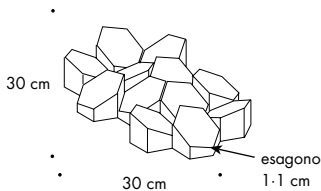

ROCK

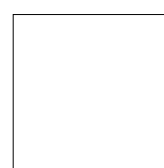

net 29-29 cm
net 11 13/16"-11 13/16"

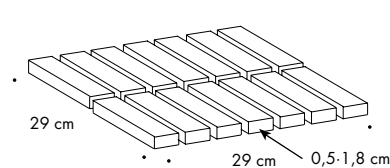

Laying and maintenance tips

use	Walls, indoors.
installation	Lay on perfectly flat, dry walls.
recommended adhesive	NON-RAPID-DRYING adhesive for porcelain stoneware to make it easier to fix the sheets.
recommended joints	Place the sheets with the same joint as within the sheet.
recommended fillers	FINE-GRAIN CEMENT-BASED GROUT: (all mosaics). Grout 0.5 m ² at a time and wash thoroughly with clean water only. Remove all traces of grout carefully before it dries completely. EPOXY GROUT: (PHENOMENON ROCK GLOSSY BIANCO and PHENOMENON ROCK GLOSSY NERO only). Grout 0.5 m ² at a time and wash thoroughly with clean water. Remove all traces of grout carefully before it dries completely. Do not use epoxy grout for ORO and ARGENTO finishes and for version RAIN A and HONEYCOMB B in GLOSSY BIANCO and NERO finishes.
cleaning at the end of the work	CEMENT-BASED GROUT: Grout 0.5 m ² at a time and wash thoroughly with clean water. Remove all traces of grout carefully before it dries completely. EPOXY GROUT: (PHENOMENON ROCK GLOSSY BIANCO and PHENOMENON ROCK GLOSSY NERO only) Alkaline detergent (e.g. FILA CR10 by FILA). FILA CR10: apply pure, wait for 30 minutes then use a green scotch Brite pad. Do not use epoxy grout for ORO and ARGENTO finishes and for version RAIN A and HONEYCOMB B in GLOSSY BIANCO and NERO finishes. Clean with water only.
advice for routine cleaning	We advise using neutral detergent diluted in water. Do not use acid or alkaline products, waxes and/or stains. Where possible, for routine cleaning avoid the use of abrasive sponges (scouring pads, metal sponges).
calibers (real size)	–

Colors

RAIN A GLOSSY



Rain A Bianco Glossy



Rain A Nero Glossy



Rain A Oro



Rain A Argento

HONEYCOMB B GLOSSY



Honeycomb B Bianco Glossy



Honeycomb B Nero Glossy



Honeycomb B Oro



Honeycomb B Argento

ROCK GLOSSY



Rock Bianco Glossy



Rock Nero Glossy



Rock Oro

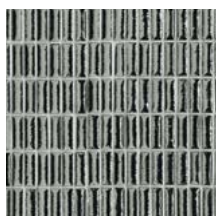

Rock Argento

Technical features

STANDARD	FEATURES	VALUE REQUIRED	PHENOMENON
ISO 10545/3	water absorption	< 0,5%	0,1%
ISO 10545/9	resistance to thermal shock	no visible alteration	resistant
ISO 10545/12	frost resistance	no visible alteration	resistant
ISO 10545/13	resistance to chemical attacks	minimum B	A B glossy finishing
ISO 10545/14	stains resistance	minimum 3	5
VOC Emission			available upon request
Declaration of Contents			available upon request
EPD			available upon request
SDS			available upon request
BPD3			available upon request
HPD			available upon request

Packing

SIZE	PCS-SQM	PCS-BOX	SQM-BOX	BOX-PAL	KG-BOX	KG-PAL	SQM-PAL
rain A net 25-30 cm	13,34	5	0,375	60	4,55	273,00	22,50
rain B net 25-30 cm	13,34	5	0,375	60	4,55	273,00	22,50
rain C net 25-30 cm	13,34	5	0,375	60	4,55	273,00	22,50
honeycomb A net 30-30 cm	11,11	8	0,72	42	7,50	315,00	30,24
honeycomb B net 30-30 cm	11,11	8	0,72	42	8,55	315,00	30,24
rock net 29-29 cm	11,90	11	0,92	42	8,10	340,00	38,64
air net 30-30 cm	11,11	11	0,99	42	10,10	424,00	41,58
wind net 25-25 cm	16,00	8	0,50	60	5,60	336,00	30,00
raccordo esterno honeycomb A+B 9,4-7,6-7,3 cm	86 ml	26	0,30	-	0,05	-	-